

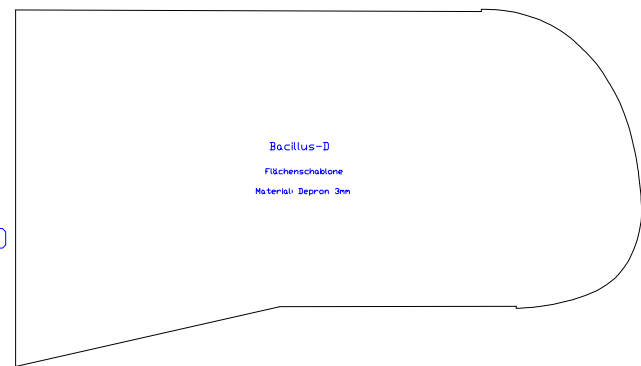

Bacillus-D
Höhenleitwerk
Depron 3mm

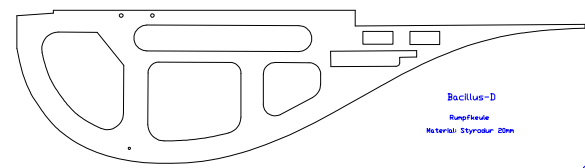

Slowflyer Bacillus-D
Spannweite 1000mm
Verkleinerte Version

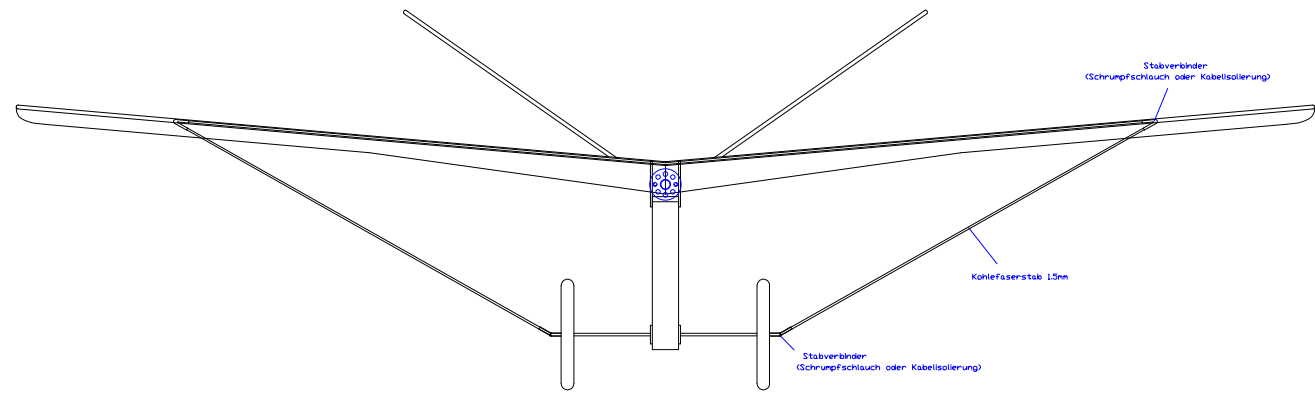
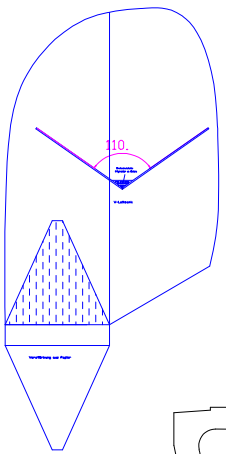
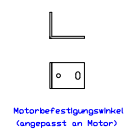

Motorbefestigungswinkel CDR-Motor

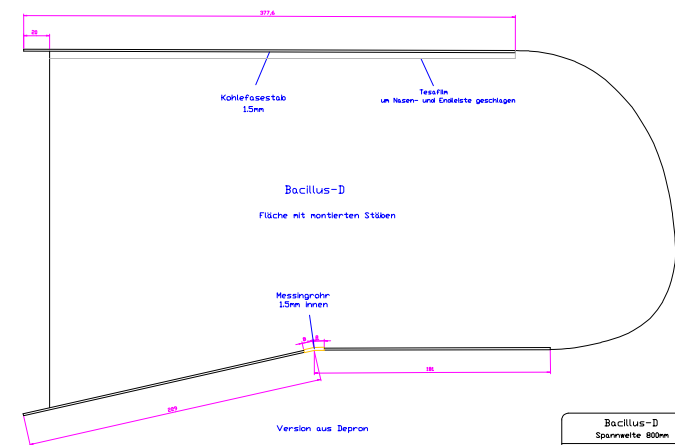
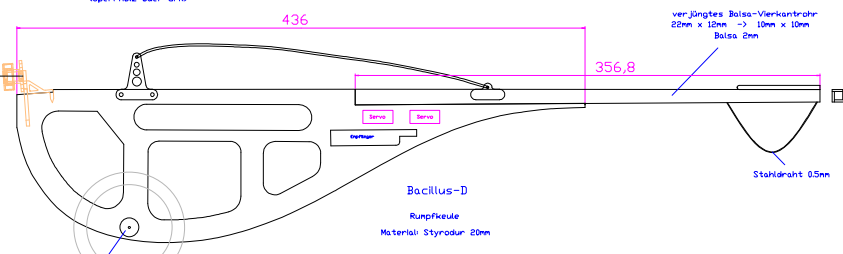
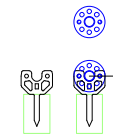

Verstärkungsscheibe (Sperrholz oder GFK)

Rechnerische Form - 07.03.2016
Mit Montagehilfe für Flächenhalter - 03.03.2014

Bacillus-D Spannweite 800mm
Idee: Patrik Svejch Plan: Dieter Stoehlein Stand: 01.11.2015
Generelle Nutzung verboten

